

Renfell Engineering Pty Ltd

RS422 4 Wire

FX30 Internet of Things card

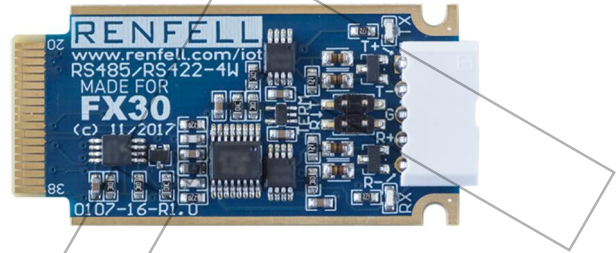

Introduction

The Renfell Engineering RS422 4 Wire IoT card allows the user to add a high-speed RS422 serial port to Sierra Wireless products that support the IoT expansion slot – the FX30 programmable IoT Gateway and mangOH™ family of boards. Based around a highly integrated FTDI chipset, standard and non-standard baud rates from 183 baud up to 3Mbaud are available. Separate TX and RX LEDs provide a visual indication of transmit and receive data as an aide to debugging data communications.

Table of contents

Introduction	1
Items Supplied in the Kit.....	2
Board Overview.....	2
Block Diagram.....	3
Connection Details.....	3
Assembling the IoT card into the FX30.....	4
Usage Example.....	6
Test that the IoT card is recognised by the FX30.....	6
Errata.....	6
References	6

Important Notice

The system(s) designed and implemented by Renfell Engineering Pty Ltd are not intended or authorised for use in any medical appliance, device, systems or any other like situations or applications where a failure to perform may result in injury or loss of life to the user or any third party.

This product and its documentation are supplied on an as-is basis and no warranty as to their suitability for any particular purpose is either made or implied.



This document provides information that may be subject to change without notice.

Renfell Engineering Pty Ltd assumes no liability whatsoever, and Renfell Engineering Pty Ltd disclaims any express or implied warranty relating to the sale and/or use of systems including liability or warranties relating to fitness for a particular purpose, merchantability, or infringement of any patent, copyright or other intellectual property right.

The FX30 programmable IoT Gateway is a product of Sierra Wireless, Inc. FX30™, mangOH™, Legato™ and the mangOH™ symbol are Registered Trademarks® of Sierra Wireless, Inc and are used with permission. All other product and company names are trademarks™ or registered® trademarks of their respective holders. Use of them does not imply any affiliation with or endorsement by the respective trademark owners

Items Supplied in the Kit

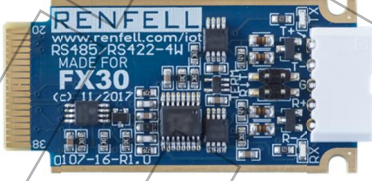
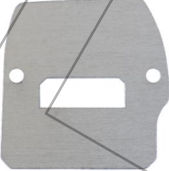
The following items are supplied in the kit. Please check carefully that all items are present and contact your supplier if any are missing.

1	RS422 4Wire IoT Card	
2	Aluminium endplate for FX30	
3	2 x 2mm pitch jumper shunts	
4	2 x M2 x 6 Pan head screws	
5	Identification sticker	

Please note:

1. the jumper shunts may or may not be pre-installed on the IoT card
2. the Aluminium endplate and M2 screws may be packaged together

Board Overview

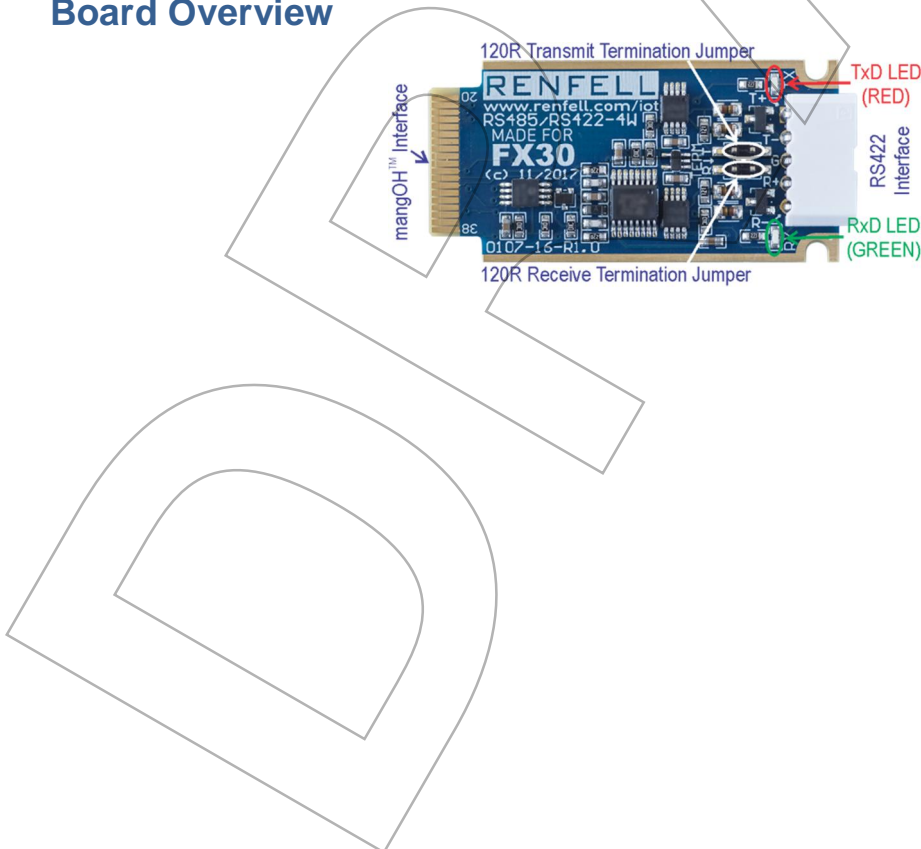

Block Diagram

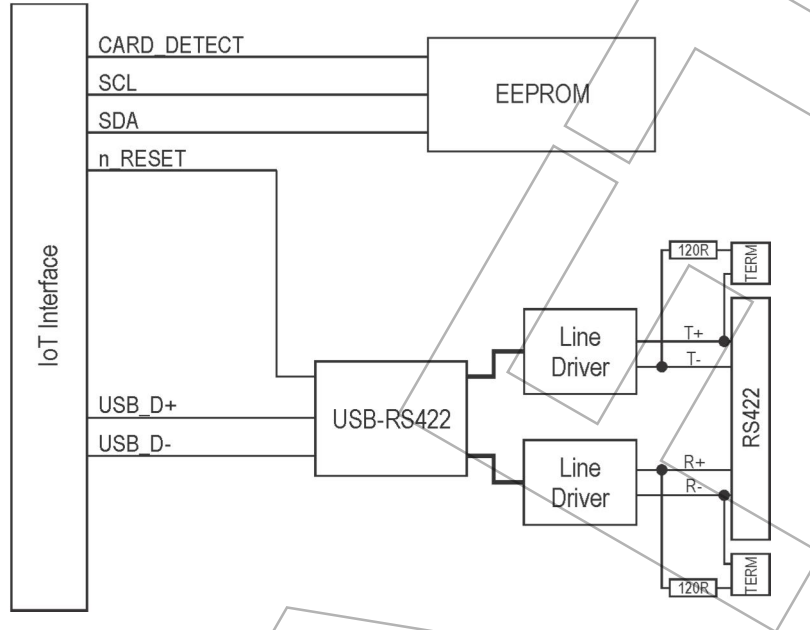

Connection Details

The IoT card is fitted with a 5 way Phoenix Contact COMBICON PTSM 0,5/5-HH-2,5 socket and requires the matching Phoenix Contact COMBICON PTSM 0,5/5-P-2,5 screwless plug (not supplied with the IoT card).

The plug is available in two versions – they are identical except for the colour

Supplier	Order Number (Black)	Order Number (White)
Phoenix Contact	1778861	1704858
Digikey	277-2325-ND	
Element 14	277-6563	
Mouser	651-1778861	651-1704858
RS Components	712-4487	

Your IoT card distributor may also have small quantities of the appropriate connector available for purchase along with the IoT card.

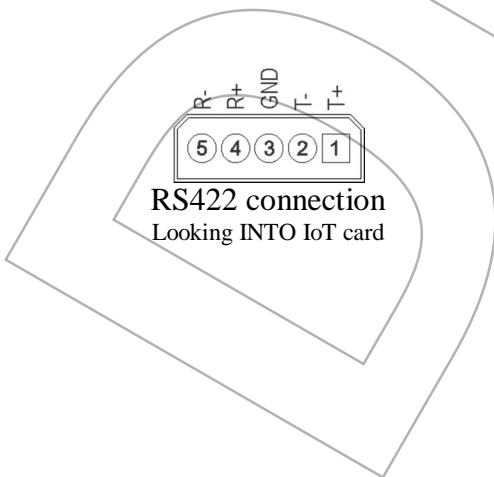

RS422 connection
Looking INTO IoT card

Signal Name	Direction into IoT card	PTSM Pin No	Description
T+	OUT	1	
T-	OUT	2	
R+	IN	4	
R-	IN	5	
GND		3	

Assembling the IoT card into the FX30

Some minor electronic and mechanical skills are required to assemble the IoT card and the FX30.

- Skill Level: Easy
Tools Required: ESD safe workspace
#1 Phillips Screwdriver

NOTE: Both the FX30 and IoT card are sensitive, precision electronic devices and some care is required during assembly. If you are not comfortable doing this assembly, please get a trained technician to do it for you.

WARNING: Before commencing work, ensure that the FX30 is completely unplugged from the power supply, Ethernet/Serial connection and the GNSS/CELL antennas.

Step 1



Undo the two countersunk M2 Phillips Head screws and set them aside

Step 2

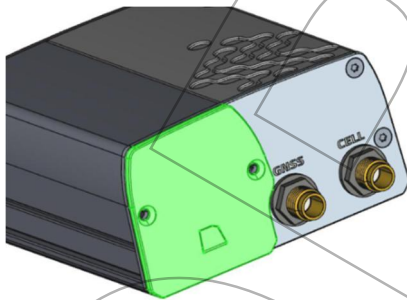

Once both screws have been removed, take the original end-plate off the FX30 and set it aside.

Step 3



After removing the end-plate, the IoT slot (and SIM slot) can be accessed

Step 4

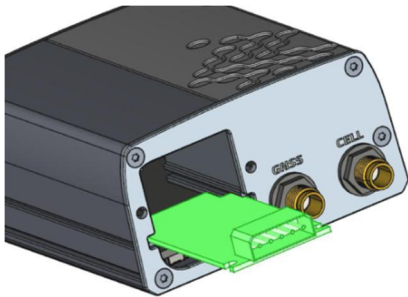

Carefully line up the IoT card with the slots in the aluminium extrusion. Take care that both edges of the IoT card are in the slots – it is possible to put the card in on a slight angle and then it won't seat home correctly

Step 5



Gently push the IoT card into the slot. There should be almost no force required at this point. The IoT card is ready to be seated into the edge connector in the FX30 once the card has about 6 mm left outside the FX30 housing. Firmly push the card into the FX30 until the end of the card is flush with the outside of the FX30 housing.

Step 6



Place the replacement end-plate (supplied with the IoT card) over the end of the connector on the IoT card and line up the two screw holes.

Step 7

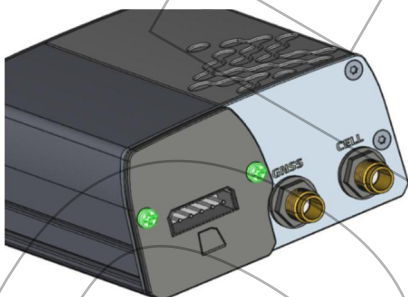

Use the two Pan-Head screws supplied with the IoT card to screw the end-plate into place. Take care when starting the screws not to cross-thread them in the FX30 or you will damage the existing threads. Likewise, do not over-tighten the screws or you will strip the thread in the FX30.

Usage Example

Note: The IoT card MUST be 'enabled' by de-asserting the *n_RESET* pin on the IoT connector before it will respond to commands. On FX30 this is done automatically in hardware.

Test that the IoT card is recognised by the FX30

1. Open a SSH windows to the FX30 unit and log in as root.
2. In the SSH window, type the following at the shell prompt:

```
logread -f | grep -i "usb"
```

3. Insert the IoT card into the slot on the FX30. Something similar to the following should be displayed in the first SSH window:

```
Jan 6 00:05:08 fx30 user.info kernel: [ 301.936181] usb 1-1.3.3: new full-speed USB device number 9 using msm_hsic_host
Jan 6 00:05:08 fx30 user.info kernel: [ 302.030367] ftdi_sio 1-1.3.3:1.0: FTDI USB Serial Device converter detected
Jan 6 00:05:08 fx30 user.info kernel: [ 302.050144] usb 1-1.3.3: Detected FT-X
Jan 6 00:05:08 fx30 user.info kernel: [ 302.052891] usb 1-1.3.3: Number of endpoints 2
Jan 6 00:05:08 fx30 user.info kernel: [ 302.057317] usb 1-1.3.3: Endpoint 1 MaxPacketSize 64
Jan 6 00:05:08 fx30 user.info kernel: [ 302.089546] usb 1-1.3.3: Endpoint 2 MaxPacketSize 64
Jan 6 00:05:08 fx30 user.info kernel: [ 302.093514] usb 1-1.3.3: Setting MaxPacketSize 64
Jan 6 00:05:08 fx30 user.info kernel: [ 302.101327] usb 1-1.3.3: FTDI USB Serial Device converter now attached to ttyUSB0
```

Note that the formatting may be different depending on the width of the SSH window.

4. Now remove the IoT card from the FX30 board.

```
Jan 6 00:23:40 fx30 user.info kernel: [ 1413.509934] usb 1-1.3.3: USB disconnect, device number 9
Jan 6 00:23:40 fx30 user.info kernel: [ 1413.518876] ftdi_sio ttyUSB0: FTDI USB Serial Device converter now disconnected from ttyUSB0
```

To cancel the logread, click in the SSH window and press <CTRL-C> to return to the shell prompt:

```
^C
root@fx30:~#
```

Errata

1. FTDI Kernel card drivers are only available in Legato Release 16.01 for FX30™ or later

References

- Latest product information: <http://www.renfell.com/iot/index.html>
- mangOH™, FX30 and Legato Tips, Articles and Tutorials: <https://www.littlesliceofmangoh.com>
- FX30 product page: <https://www.sierrawireless.com/products-and-solutions/embedded-solutions/programmable-iot-gateways-modems/>
- mangOH™ information: <http://mango.io>
- Legato information: <http://legato.io>