

Lantech

IPES/IES-0208 Series

8 10/100TX+ 2 10/100/1000T or 1000FX (w/8 PoE at/af) IP67/IP43
rated Industrial Unmanaged Switch

User Manual



IPES-0208GF-67



IPES-0208T-67

Recommendation for Shielded network cables

STP cables have additional shielding material that is used to reduce external interference. The shield also reduces the emission at any point in the path of the cable. Our recommendation is to deploy an STP network cable in demanding electrical environments. Examples of demanding indoor environments are where the network cable is located in parallel with electrical mains supply cables or where large inductive loads such as motors or contactors are in close vicinity to the camera or its cable. It is also mandatory to use an STP cable where the power device (like IP camera) is used outdoors or where the network cable is routed outdoors.



Important Notice

Lantech Communications Global, Inc. reserves the right to modify the equipment, its specification or this manual without prior notice, in the interest of improving performance, reliability, or servicing. At the time of publication all data is correct for the operation of the equipment at the voltage and/or temperature referred to. Performance *data* indicates typical values related to the particular product.

No part of this documentation or information supplied may be divulged to any third party without the express written consent of Lantech Communications Global Inc. Products offered may contain software which is proprietary to Lantech Communications Global Inc. The offer or supply of these products and services does not include or infer any transfer of ownership.

Interference Issues

This Equipment has been tested and found to comply with the limits for a Class A digital device, pursuant to Part 15 of the FCC rules. These limits are designed to provide reasonable protection against harmful interference in a commercial or industrial installation. This equipment generates, uses, and can radiate radio frequency energy. It may cause harmful interference to radio communications if the equipment is not installed and used in accordance with the instructions.

FCC Warning

This Equipment has been tested and found to comply with the limits for a Class-A digital device, pursuant to Part 15 of the FCC rules. These limits are designed to provide reasonable protection against harmful interference in a residential installation. This equipment generates, uses, and can radiate radio frequency energy. It may cause harmful interference to radio communications if the equipment is not installed and used in accordance with the instructions. However, there is no guarantee that interference will not occur in a particular installation. If this equipment does cause harmful interference to radio or television reception, which can be determined by turning the equipment off and on, the user is encouraged to try to correct the interference by one or more of the following measures:

- Reorient or relocate the receiving antenna.
- Increase the separation between the equipment and receiver.
- Connect the equipment into an outlet on a circuit different from that to which the receiver is connected.
- Consult the dealer or an experienced radio/TV technician for help.

CE Mark Warning

This is a Class-A product. In a domestic environment this product may cause radio interference in which case the user may be required to take adequate measures.

Content

Chapter 1 Introduction	5
Chapter 2 Hardware Description.....	6
2.1 Physical Dimension.....	6
2.2 Package Content:	9
2.3 IP Protection	9
2.4 LED Indicators	12
Chapter 3 Hardware Installation	13

Chapter 1 Introduction

Lantech IPES-0208 series are 8 10/100 Base-TX+ 2 10/100/1000T or 1000FX or 100FX (w/8 PoE at/af injectors) with M12-connector unmanaged industrial switches for IP67 or IP43 rated protection, which meets the high reliability requirements demanded by industrial rolling stock applications.

Model List:

IPES-0208GF	8 10/100TX + 2 1000FX w/ 8 PoE at/af Industrial Unmanaged Switch
IES-0208GF	8 10/100TX + 2 1000FX Industrial Unmanaged Switch
IPES-0208T	8 10/100TX + 2 10/100/1000T w/ 8 PoE at/af Industrial Unmanaged Switch
IES-0208T	8 10/100TX + 2 10/100/1000T Industrial Unmanaged Switch

Chapter 2 Hardware Description

In this paragraph, it will describe the Industrial switch's hardware spec, port, cabling information, and wiring installation.

2.1 Physical Dimension

Aluminum case. IP-67,

IPES-0208GF	215mm(W)x200mm(H)x83.3mm(D)
IES-0208GF	215mm(W)x200mm(H)x76.7mm(D)
IPES-0208T	215mm(W)x201.4mm(H)x83.3mm(D)
IES-0208T	215mm(W)x201.4mm(H)x76.7mm(D)

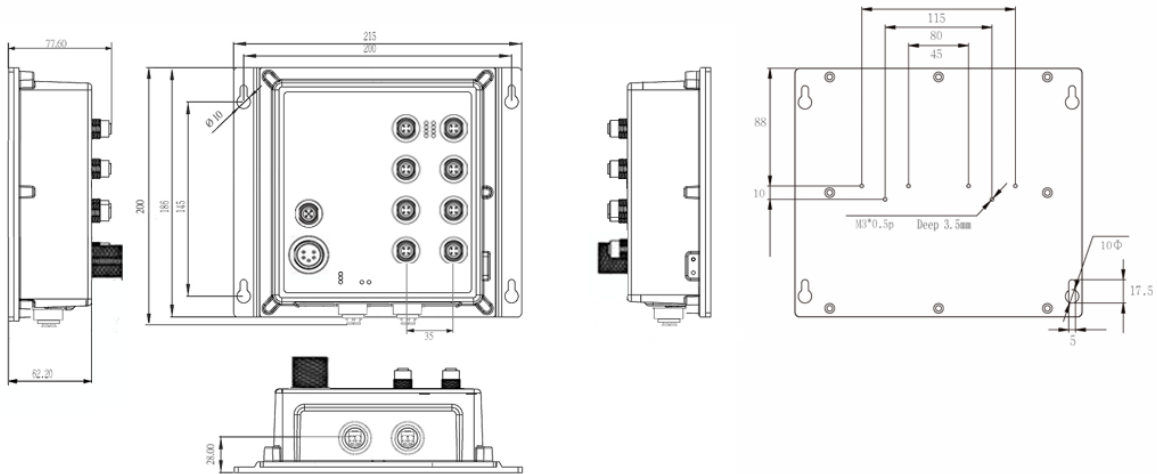

Aluminum case. IP-43,

IPES-0208GF	203mm(W)x187mm(H)x84.4mm(D)
IES-0208GF	203mm(W)x187mm(H)x77.6mm(D)
IPES-0208T	203mm(W)x188.4mm(H)x84.4mm(D)
IES-0208T	203mm(W)x188.4mm(H)x77.6mm(D)

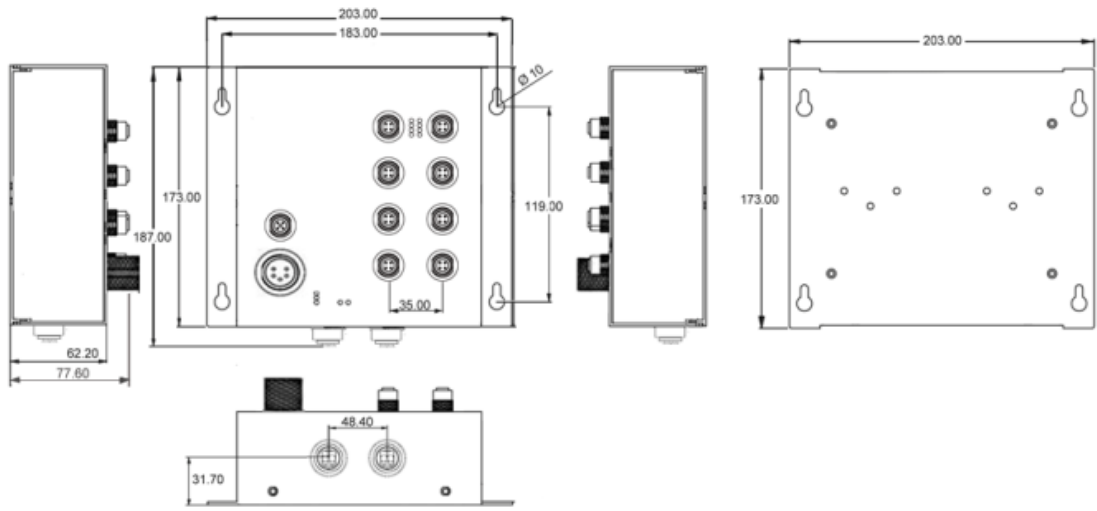

Port description of IP67-rated switch

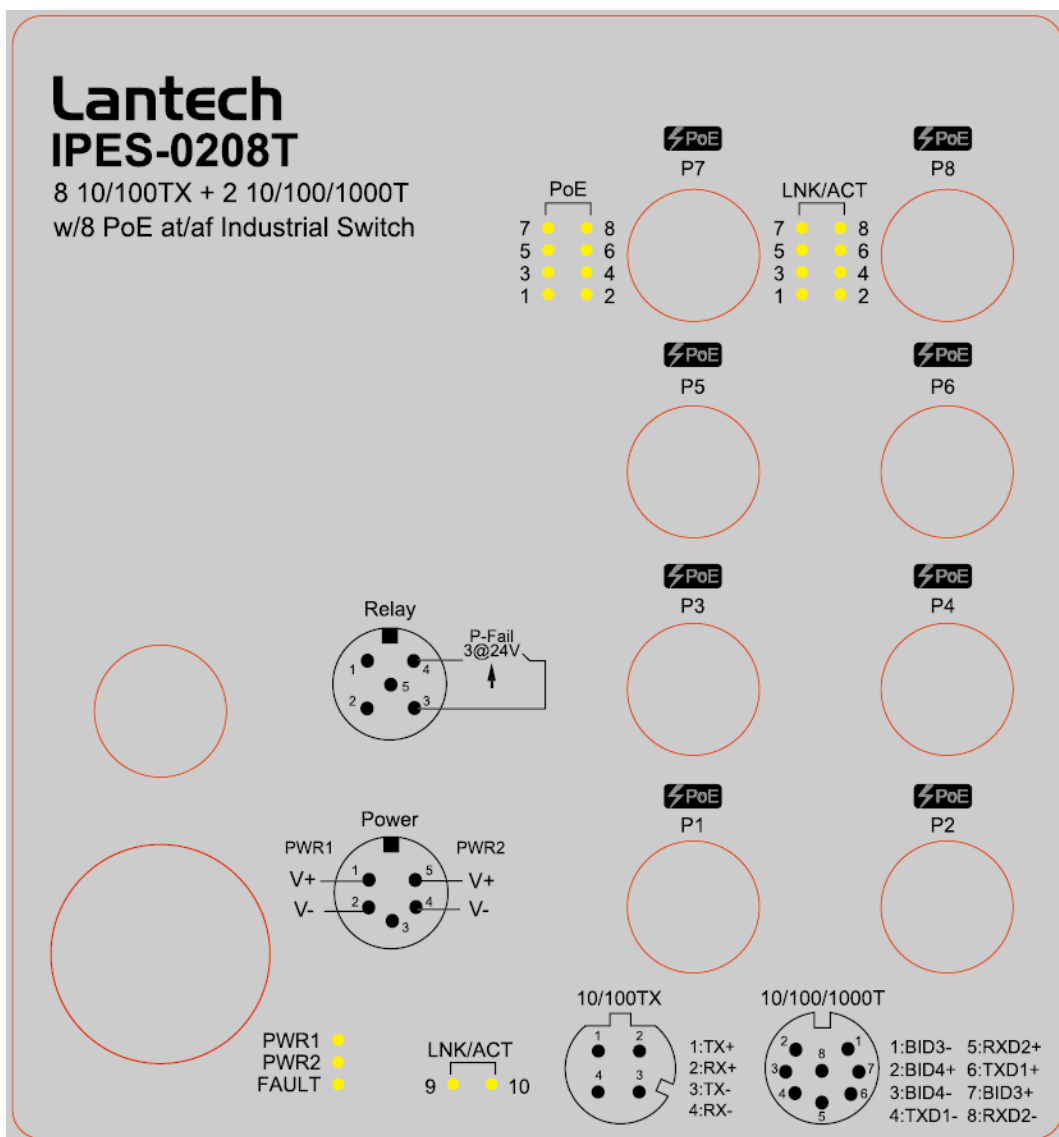

****The port description of IP43 model is the same as of IP67 one.**

2.2 Package Content:

- Industrial Switch
- Quick Installation Guide (available since Jan 2017)

2.3 IP Protection

The **IP Code, Ingress Protection Rating**, sometimes also interpreted as **International Protection Rating**, classifies and rates the degree of protection provided against the intrusion (including body parts such as hands and fingers), dust, accidental contact, and water in *mechanical casings* and with electrical enclosures. It is published by the International Electrotechnical Commission (IEC)

Solid particle protection

The first digit indicates the level of protection that the enclosure provides against access to hazardous parts (e.g., electrical conductors, moving parts) and the ingress of solid foreign objects.

Level	Object size protected against	Effective against
0	—	No protection against contact and ingress of objects
1	>50 mm	Any large surface of the body, such as the back of a hand, but no protection against deliberate contact with a body part
2	>12.5 mm	Fingers or similar objects
3	>2.5 mm	Tools, thick wires, etc.
4	>1 mm	Most wires, screws, etc.
5	Dust protected	Ingress of dust is not entirely prevented, but it must

		not enter in sufficient quantity to interfere with the satisfactory operation of the equipment; complete protection against contact
6	Dust tight	No ingress of dust; complete protection against contact

Liquid ingress protection

The second digit indicates the level of protection that the enclosure provides against harmful ingress of water.

Level	Protected against	Testing for	Details
0	Not protected	—	—
1	Dripping water	Dripping water (vertically falling drops) shall have no harmful effect.	Test duration: 10 minutes Water equivalent to 1 mm rainfall per minute
2	Dripping water when tilted up to 15°	Vertically dripping water shall have no harmful effect when the enclosure is tilted at an angle up to 15° from its normal position.	Test duration: 10 minutes Water equivalent to 3 mm rainfall per minute
3	Spraying water	Water falling as a spray at any angle up to 60° from the vertical shall have no harmful effect.	Test duration: 5 minutes Water volume: 0.7 litres per minute Pressure: 80–100 kPa
4	Splashing of water	Water splashing against the enclosure from any direction shall have no harmful effect.	Test duration: 5 minutes Water volume: 10 litres per minute Pressure: 80–100 kPa

5	Water jets	Water projected by a nozzle (6.3 mm) against enclosure from any direction shall have no harmful effects.	Test duration: at least 15 minutes Water volume: 12.5 litres per minute Pressure: 30 kPa at distance of 3 m
6	Powerful water jets	Water projected in powerful jets (12.5 mm nozzle) against the enclosure from any direction shall have no harmful effects.	Test duration: at least 3 minutes Water volume: 100 litres per minute Pressure: 100 kPa at distance of 3 m
7	Immersion up to 1 m	Ingress of water in harmful quantity shall not be possible when the enclosure is immersed in water under defined conditions of pressure and time (up to 1 m of submersion).	Test duration: 30 minutes Immersion at depth of at least 1 m measured at bottom of device, and at least 15 cm measured at top of device
8	Immersion beyond 1 m	The equipment is suitable for continuous immersion in water under conditions which shall be specified by the manufacturer. Normally, this will mean that the equipment is hermetically sealed. However, with certain types of equipment, it can mean that water can enter but only in such a manner that	Test duration: continuous immersion in water Depth specified by manufacturer

		it produces no harmful effects.	
9	Powerful high temperature water jets	Protected against close-range high pressure, high temperature spray downs.	—

2.4 LED Indicators

The diagnostic LEDs that provide real-time information of system and optional status are located on the front panel of the industrial switch. The following table provides the description of the LED status and their meanings for the switch.

LED	Color	Status	Meaning
PWR1	Green	On	Power 1 is active
		Off	Power 1 is inactive
PWR2	Green	On	Power 2 is active
		Off	Power 2 is inactive
FAULT	Red	On	Power or port failure
		Off	No failure
P1 ~ P8	Link/Ack	On	A network device is detected.
		Blinking	The port is transmitting or receiving packets from the TX device.
		Off	No device attached
	PoE(1~8)(IPES)	On	The port is operating in PoE mode.(IPES)
		Off	The port is not operating in PoE mode.(IPES)

Chapter 3 Hardware Installation

3.1 Hardware installation

3.1.1 Unpack switch and check the accessory with packing content list

3.1.2 Mount the switch on desired position. For the best ventilation, it is suggested to mount the switch on metallic surface.

3.1.3 Connect the M23/M12 connector of power input. The PoE power supply for IPES-0208 series is connected via a 5-pole M23 female connector.

■ Voltage of Power Input

Non-PoE model	Standard model: The power input voltage can be from 9.5V to 60VDC
	72V model: The power input voltage can be from 50.4V to 90VDC
	110V model: The power input voltage can be from 43V to 137.5VDC
PoE model	Standard model: The voltage of power input should use 48VDC to feed power IEEE 802.3af standardized devices or 54VDC for IEEE 802.3at standardized ones.
	12V model: The power input voltage can be from

	9.5V to 56VDC to feed power on both the 802.3af and 802.3at standardized devices.
	72V model: The power input voltage can be from 50.4V to 90VDC to feed power on both 802.3af/at standardized devices.
	110V model: The power input voltage can be from 43V to 137.5VDC to feed power on both 802.3af/at standardized devices.

Please make sure that the external power supply unit you use to provide the PoE voltage meet the following criteria:

- The output voltage of power supply must exceed 48VDC for 802.3af and 53VDC for 802.3at operation (*with IPES 72V models, only 72VDC can power both the 802.3af and 802.3at PD. **with IPES 110V models, only 110VDC can power both the 802.3af and 802.3at PD.)
- The power consumption can satisfy the total power request from all PD devices required.

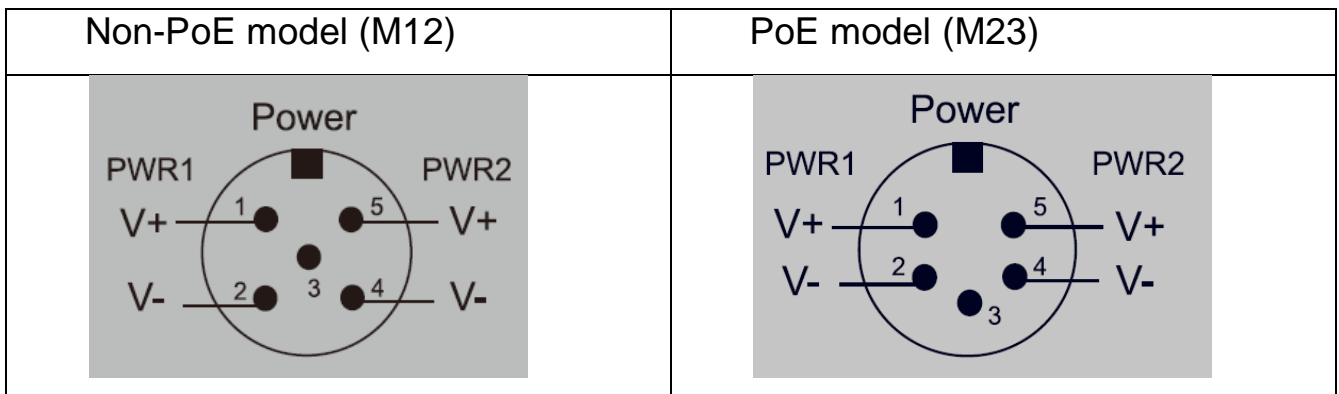

Pin assignment of Power input

■ Redundant Power Input

The power input can be supported redundantly. The supply voltage is electrically isolated from the housing.

Note: With single power supply of the mains voltage, the device will report a power failure.

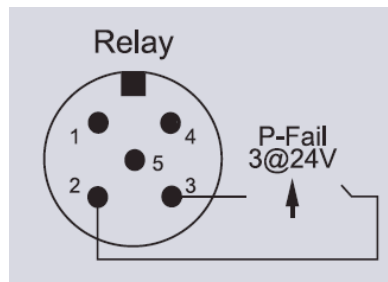

Pin assignment of alarm relay

A break in contact is reported via the relay contact :

- The failure of at least one of the two supply voltages.
- The break link status of at least one switch port.

3.1.4 Fitting the device, grounding

Install the system in a dry and clean area to protect the switch to get exposed with dirt.

Plug the connector to the power supply plug then turn on the power supply.

■ Ground

The chassis is grounded via a separate ground nut (M3).

Use toothed locking washers for a good electrical connection.



Ground screw of IPES-0008A switch

3.1.5 Connect the M12 connector with RJ-45 data cable, ports are not used shall be capped that comes with the package to insulate the surrounding.

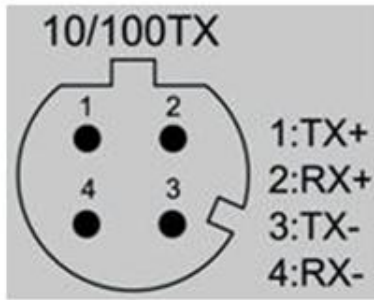

Switch connector

<->

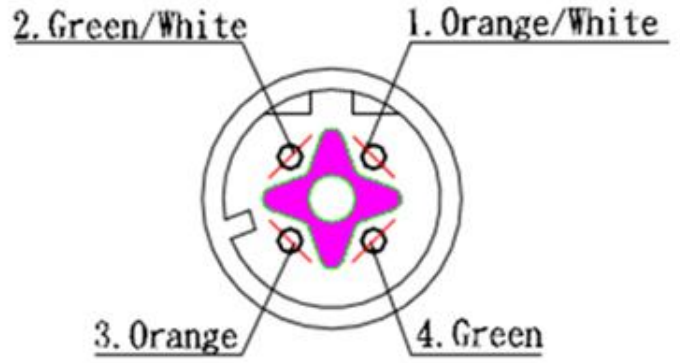

Cable connector

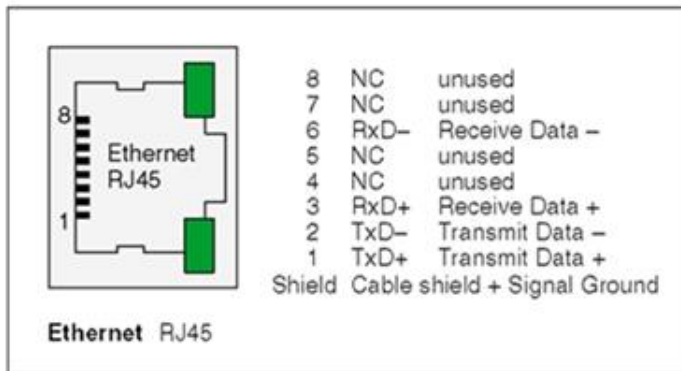

Ethernet RJ45

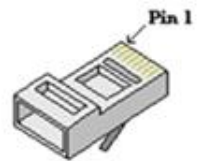
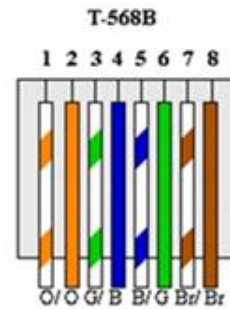

RJ-45 Plug

Pin assignment of M12 10/100Tx network connector

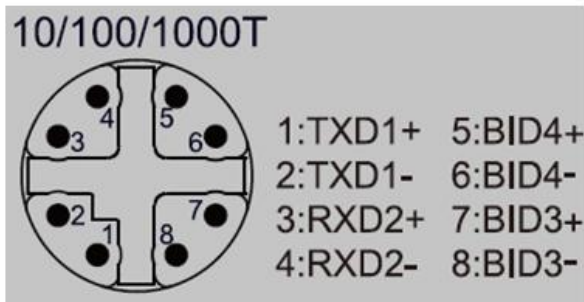

Switch connector

<->

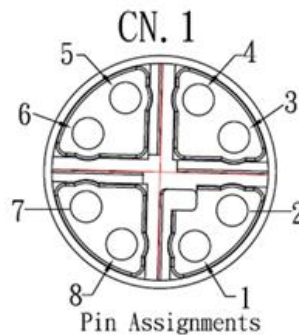

Cable connector

Shell	Gnd	Shell	
1	Orange/ White	1	TWIST
2	Orange	2	
3	Green/ White	3	TWIST
4	Green	6	
5	Brown/ White	7	TWIST
6	Brown	8	
7	Blue/ White	5	TWIST
8	Blue	4	
CN. 1	Wire Color	CN. 2	
	PIN	OUT	

T-568B

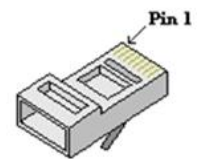
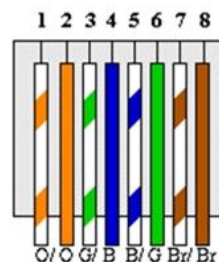

RJ-45 Plug

Pin assignment of M12 10/100/1000T network connector

Note:

- The protection class IP67/IP43 is only achieved when bolted together.
- The other components attaching to the system have to meet with the IP67/IP43 protection class in order to reach the whole system IP67/IP43 protection.
- Empty ports must be sealed with the protective caps supplied.